

Varenummer: 20021393
 Beskrivelse: E+G Positioneringsbolt
 GN 607.3-8-10-ST

Mål

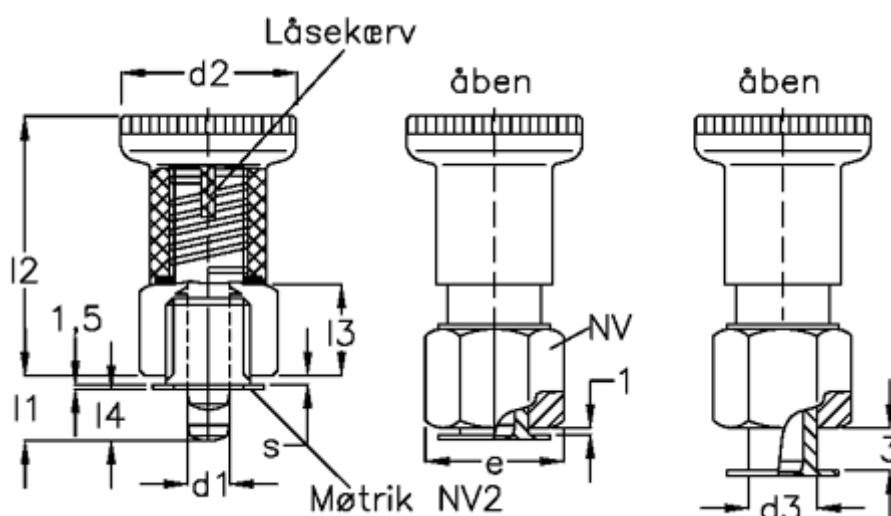

AL	= 500	l2	= 40
d1	= 8	l3	= 12
d2	= 31	l4	= 7.5
d3	= 12	NV 1	= 19
e	= 22.0	NV 2	= 16
Fjedertryk N bund	= 28	s	= 1-5
Fjedertryk N top	= 15.5		
l1	= 10.0		